

This design is proprietary. The reproduction and / or dissemination without permission is prohibited by in force law.

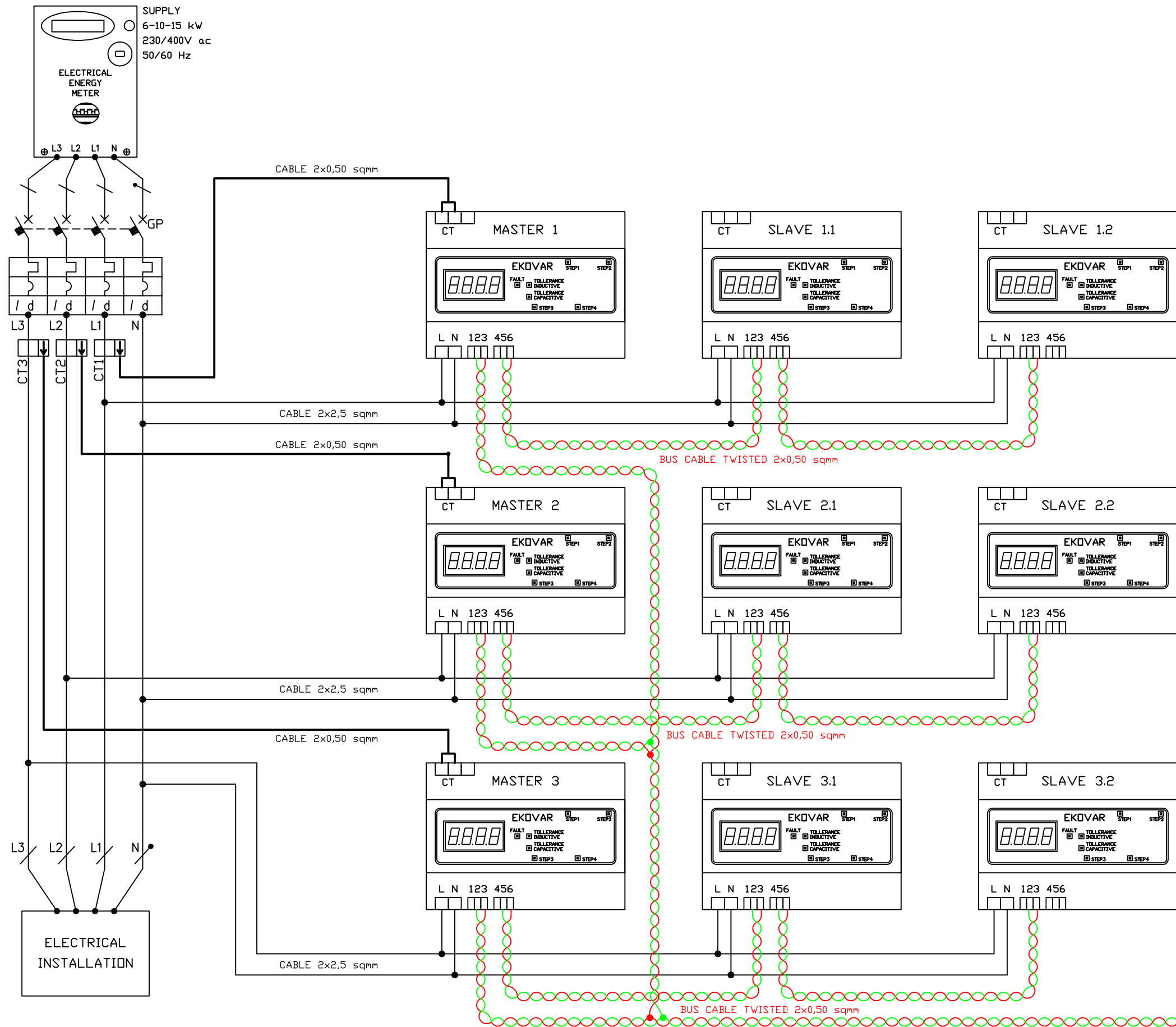

COMBINATION OF CAPACITY IN RELATION TO THE NUMBER OF DEVICES INSTALLED

EKOVAR MASTER N°	EKOVAR SLAVE N°	VALUES AVAILABLE CAPACITY
1	0	35 μF
1	1	70 μF
1	2	105 μF
1	3	140 μF
1	4	175 μF
1	5	210 μF
1	6	245 μF
1	7	280 μF
1	8	315 μF

N.B.:
Each "Ekovar master" you can add up to 8 "Ekovar slave"

Legend:
 GP - GENERAL PROTECTION DEVICE
 CT - CURRENT TRANSFORMER PRIMARY 75A
 CN - SIGNAL CONVERTER RS485 - USB

